

Sc

KEY STAGE

3

TIER

5-7

Science test

Paper 2

First name _____

Last name _____

School _____

Remember

- The test is 1 hour long.
- You will need: pen, pencil, rubber, ruler, protractor and calculator.
- The test starts with easier questions.
- Try to answer all of the questions.
- The number of marks available for each question is given below the mark boxes in the margin. You should not write in this margin.
- If you are asked to plan an investigation, there will be space for you to write down your thoughts and ideas.
- Do not use any rough paper.
- Check your work carefully.
- Ask your teacher if you are not sure what to do.

For marker's use only

TOTAL MARKS	
-------------	--

1. The drawings below show Caroline diving into a swimming pool.
As she falls, gravitational potential energy is changed into kinetic energy.

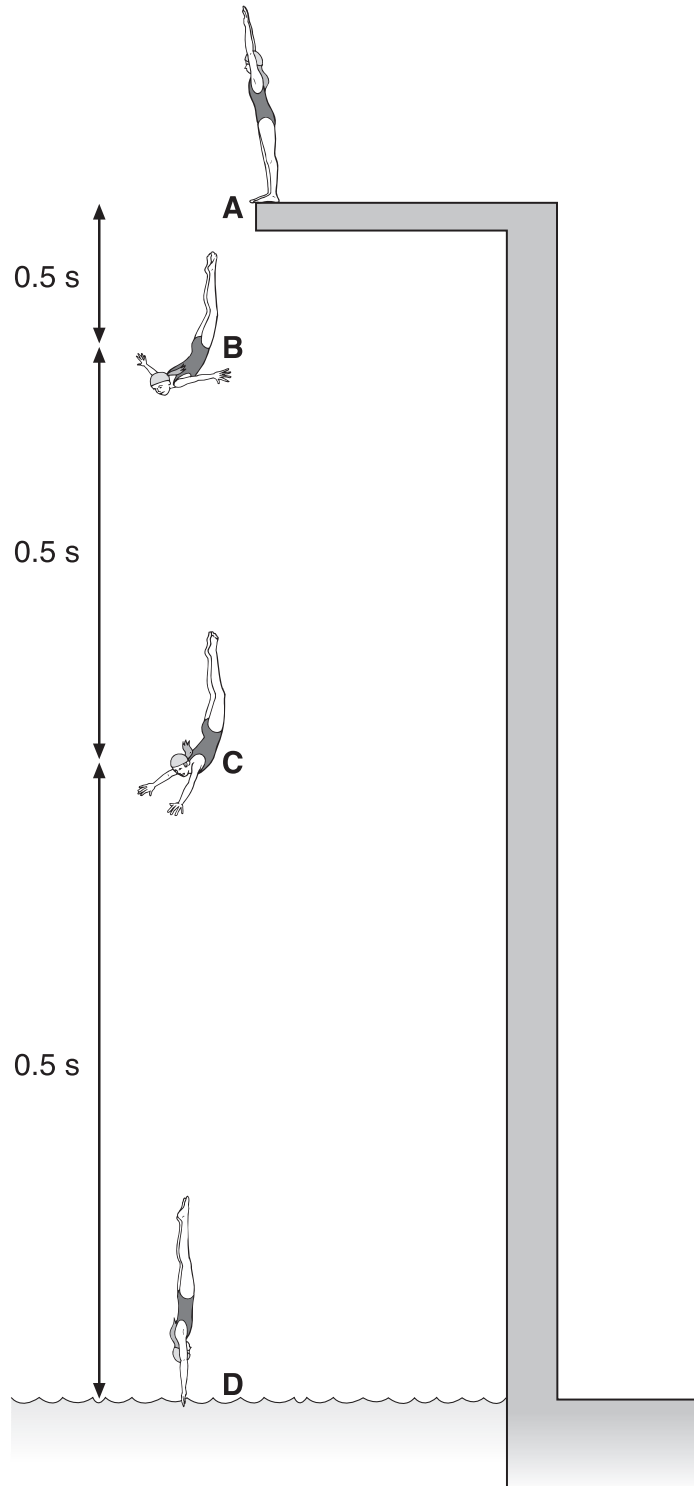

- (a) Why does Caroline have **no** kinetic energy at A?

1a
1 mark

- (b) The table shows Caroline's gravitational potential energy and kinetic energy at four stages of the dive.

stage of the dive	total energy (kJ)	gravitational potential energy (kJ)	kinetic energy (kJ)
A	8	8	0
B	8	7	1
C	8	4	4
D	8	0	

- (i) Write the missing kinetic energy value for stage D in the table.

1bi
1 mark

- (ii) As Caroline falls there is **no** loss of energy to the air. How do the energy values for stages A, B, C and D show this?

1bii
1 mark

- (c) (i) Give the name of the force that causes Caroline to speed up as she falls.

1ci
1 mark

- (ii) Caroline takes 0.5 s to fall from A to B **and** from B to C **and** from C to D.

How can you tell from the drawings opposite that she is speeding up as she falls?

1cii
1 mark

- (d) When Caroline enters the water she slows down. Give the name of the force that slows her down.

1d
1 mark

maximum 6 marks

2. (a) Max built **circuit 1** as shown below.

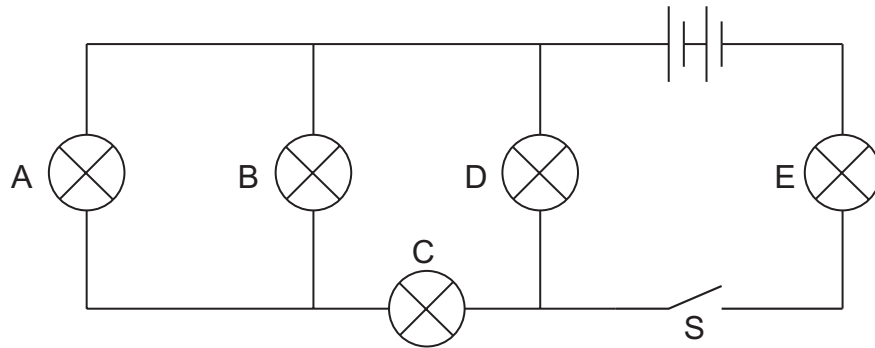

circuit 1

He closed the switch, S, and all the bulbs came on.
One of the bulbs then broke and **all** the bulbs went off.

Which bulb must have broken?
Give the letter.

2a
1 mark

(b) Max built **circuit 2** as shown below.
He connected a plastic comb and a metal key in different parts of the circuit.

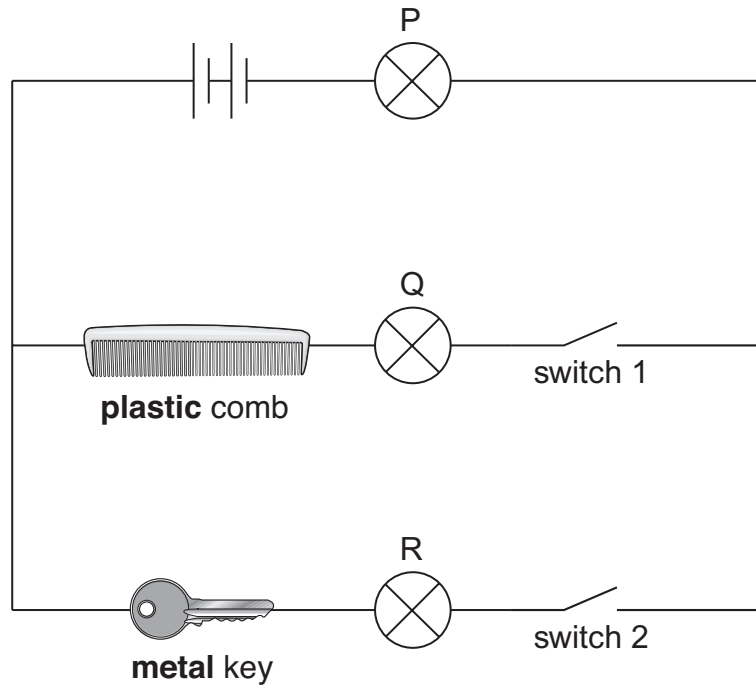

circuit 2

Look carefully at **circuit 2**.

Complete the table below to show which bulbs in circuit 2 will be on or off when different switches are open or closed.

Write **on** or **off** in the boxes below.

switch 1	switch 2	bulb P	bulb Q	bulb R
open	open	off	off	off
open	closed			
closed	open			

2b

1 mark

2b

1 mark

(c) Max built **circuit 3** using a battery, two bulbs and three ammeters.

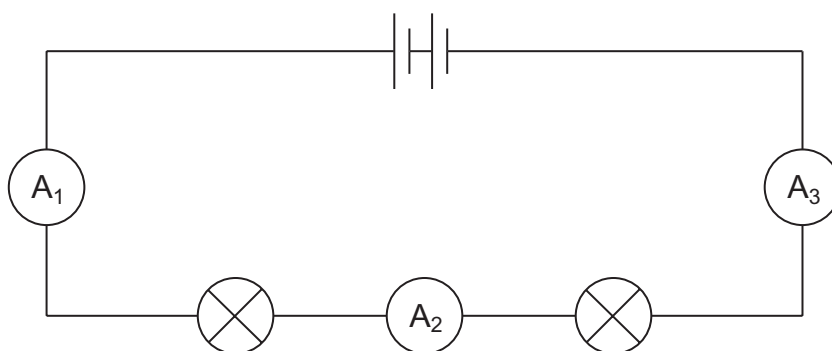

circuit 3

The current reading on ammeter A_1 was 0.8 amps.

What would be the reading on ammeters A_2 and A_3 ?

Place **one** tick in the table by the correct pair of readings.

reading on ammeter A_2 (amps)	reading on ammeter A_3 (amps)	correct pair of readings
0.8	0.8	
0.8	0.4	
0.4	0.8	
0.4	0.4	

2c

1 mark

maximum 4 marks

Total

3. Some pupils made an electric cell using two different metals and a lemon. They put strips of copper and zinc into a lemon and connected them to the terminals of an electric clock.



- (a) Look at the photograph.

What evidence is there that they have made an electric cell?

3a
1 mark

- (b) The pupils had pieces of copper, zinc, iron and magnesium and some lemons. They wanted to find out which pair of metals made the cell with the biggest voltage.

What equipment should they use to measure the voltage of their cells?

3b
1 mark

- (c) In their investigation they used different pairs of metals.

Give **one** factor that they should keep the same.

3c
1 mark

- (d) The pupils measured the voltage produced by different pairs of metals. Their results are recorded below.

voltage produced by each pair of metals (volts)				
	magnesium	zinc	iron	copper
copper	1.7	0.9	0.8	0
iron	1.3	0.1	0	-
zinc	0.8	0	-	-
magnesium	0	-	-	-

Which pair of metals made the cell with the biggest voltage?

_____ and _____

3d
1 mark

- (e) Look at the results in the table above.

Why should the pupils **not** use pairs of the same type of metal for the clock?

3e
1 mark

maximum 5 marks

4. The word equation for the reaction between magnesium carbonate and hydrochloric acid is shown below.

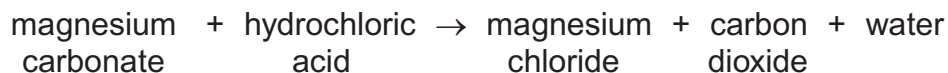

- (a) Sadiq added hydrochloric acid to magnesium carbonate in a flask.

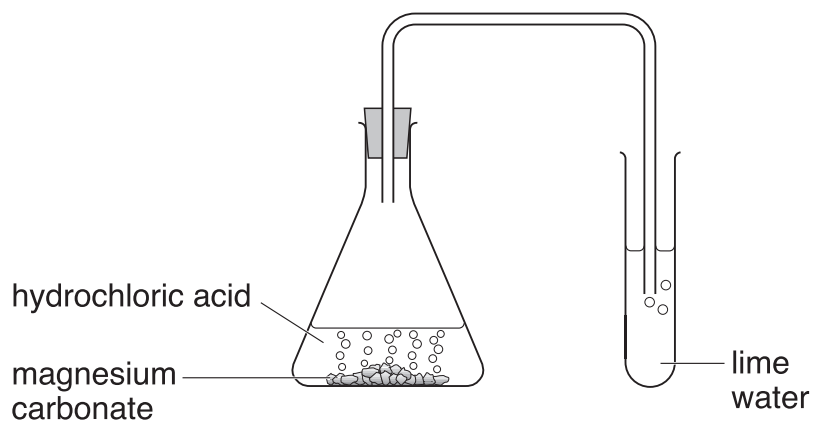

- (i) Suggest the pH of hydrochloric acid.

- (ii) The carbon dioxide produced was bubbled through lime water.

How would the lime water change?

- (b) Sadiq repeated the experiment by adding **sulphuric acid** to magnesium carbonate.

Complete the word equation for the reaction that took place.

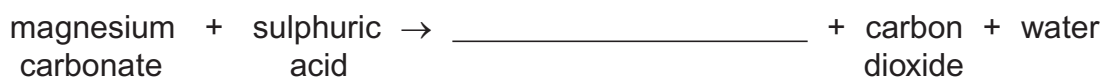

1 mark 4ai

1 mark 4aii

1 mark 4b

- (c) Sadiq made a model volcano.
He put magnesium carbonate into the model.
He added vinegar and a drop of washing-up liquid.

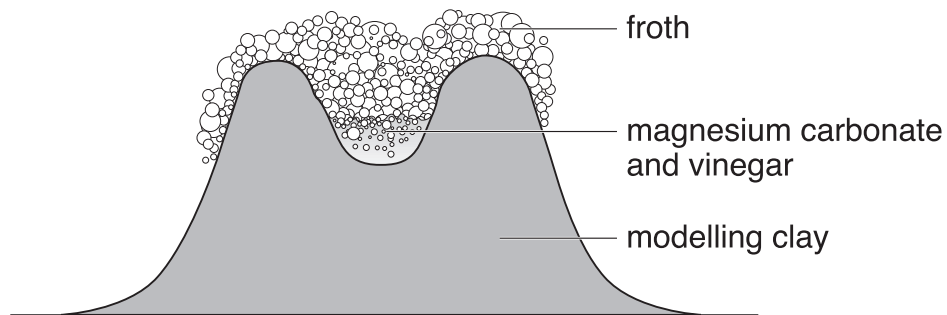

The mixture fizzed, and froth poured out of the model volcano.

- (i) The vinegar reacted with the magnesium carbonate.

Suggest the pH of vinegar.

4ci
1 mark

- (ii) The froth running down the side of the model represents part of a real volcano.
Give the name of this part.

4cii
1 mark

maximum 5 marks

5. Abi investigated how adding salt to water affects the way an object floats. She used the apparatus below.

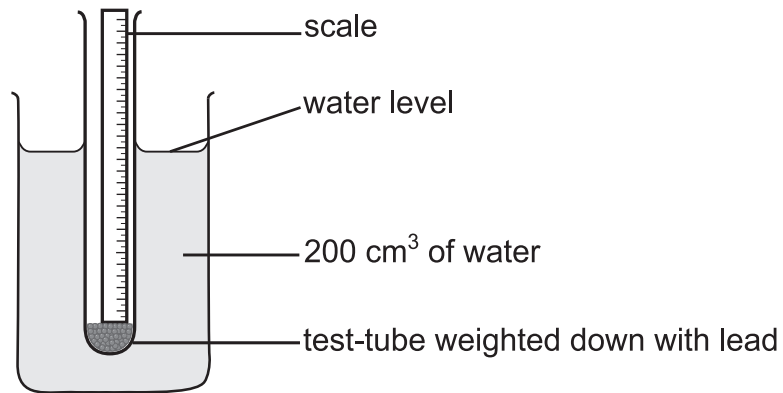

She used a scale inside a test-tube to measure the length of the test-tube above the water level.

- (a) What factor did Abi change as she carried out her investigation (the independent variable)?

5a
1 mark

- (b) Abi plotted her results on a graph.

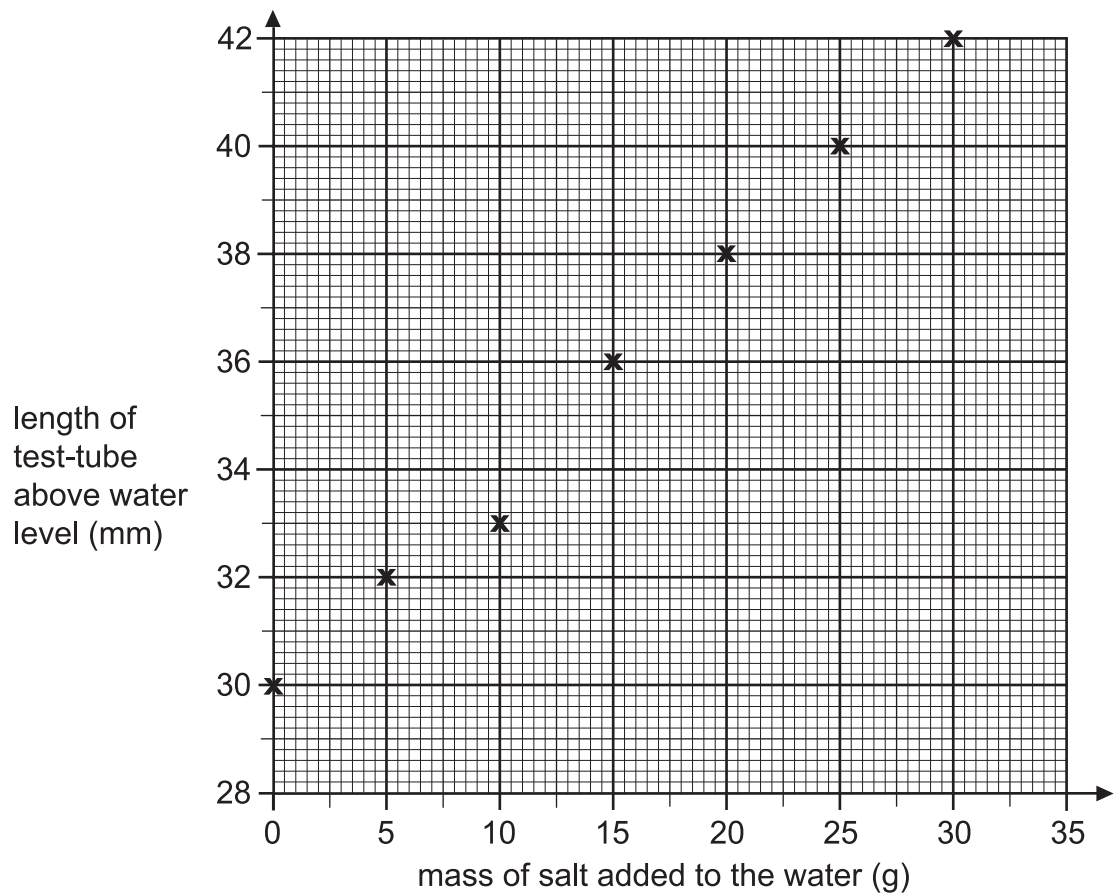

(i) **On the graph**, circle the result which does **not** fit the pattern.

5bi
1 mark

(ii) Suggest **one** reason for this result.

5bii
1 mark

(c) Abi said she should repeat the measurement that does **not** fit the pattern. Robert said there is **no** need to repeat this measurement.

Who do you agree with?
Tick **one** box.

Abi Robert

Explain your answer.

5c
1 mark

(d) Abi and Robert wrote the conclusions listed below.

Look at the graph of their results and tick whether each conclusion is **true** or **false** or whether you **cannot tell**.

conclusions	true	false	cannot tell
The more salt added, the higher the test-tube floats in the water.	<input type="checkbox"/>	<input type="checkbox"/>	<input type="checkbox"/>
The length of the test-tube is 8 cm.	<input type="checkbox"/>	<input type="checkbox"/>	<input type="checkbox"/>
When 10 g of salt is added, the length of the test-tube above the water will be 34 mm.	<input type="checkbox"/>	<input type="checkbox"/>	<input type="checkbox"/>
Doubling the amount of salt doubles the length of the test-tube above the water.	<input type="checkbox"/>	<input type="checkbox"/>	<input type="checkbox"/>

maximum 6 marks

5d
1 mark

5d
1 mark

Total

6

6. A teacher mixed iron filings with sulphur on a metal tray. She heated the mixture in a fume cupboard. Sulphur is yellow. Iron filings are grey.

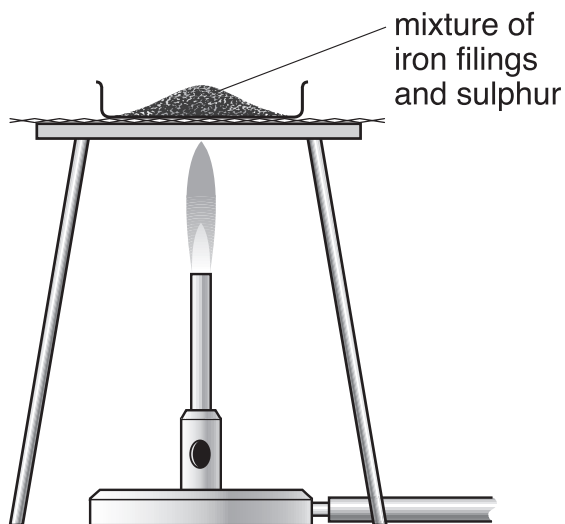

The mixture glowed very brightly. The teacher turned off the bunsen burner. The glow spread through the mixture. When the mixture cooled, a black solid called iron sulphide was left.

- (a) From this information, give **one** way you can tell that a chemical reaction took place.

6a
1 mark

- (b) What type of substance is each of the chemicals involved in this reaction? Choose from:

metallic
element

mixture

non-metallic
element

compound

iron _____

sulphur _____

iron sulphide _____

6b
1 mark

6b
1 mark

(c) Raj held a magnet near to each of the three chemicals.

By each chemical in the table, write **yes** or **no** to show if the chemical was magnetic.

One has been done for you.

chemical	Was the chemical magnetic?
sulphur	
iron	
iron sulphide	no

6c
1 mark

(d) (i) When iron is heated with sulphur, iron sulphide is formed.
Give the name of the solid formed when **zinc** is heated with sulphur.

6di
1 mark

(ii) Some fossil fuels contain sulphur.
When fuels burn, sulphur reacts with oxygen.

Complete the word equation for this reaction.

sulphur + oxygen → _____

6dii
1 mark

maximum 6 marks

7. **Table 1** gives information about 100 g of five different foods.

food	energy per 100 g of food (kJ)	nutrients per 100 g of each food			
		protein (g)	fat (g)	carbohydrate (g)	calcium (mg)
banana	403	1.2	0.3	23.2	6
wholemeal bread	914	9.2	2.5	41.6	54
butter	3031	0.5	81.7	0	15
cheese	1708	22.5	34.4	0.1	720
milk	275	3.2	3.9	4.8	115

table 1

(a) Look at **table 1**.

(i) Which of the four **nutrients**, protein, fat, carbohydrate or calcium, provides most of the energy in the cheese?

7ai

1 mark

(ii) Which of the four **nutrients** provides most of the energy in the wholemeal bread?

7aii

1 mark

(iii) Which of the four **nutrients** is needed for growth and repair?

7aiii

1 mark

(b) The recommended daily amount of protein for a woman is 45 g.

Look at **table 1**.

How many grams of cheese would provide 45 g of protein?

Tick the correct box.

7b

1 mark

50 g

100 g

150 g

200 g

- (c) **Not** all the types of nutrients needed for a balanced diet are shown in **table 1**.

Give the name of **one** of the missing types of nutrient.

7c

1 mark

- (d) **Table 2** shows the recommended daily amount of calcium for a person in four stages of the human life cycle.
We need calcium for healthy teeth and bones.

person	recommended daily amount of calcium (mg)
a baby aged 6 months	600
a woman before she is pregnant	500
a pregnant woman	1200
a breast-feeding woman	

table 2

- (i) Use information in **table 2** to estimate how much calcium a breast-feeding woman should have each day.

_____ mg

7di

1 mark

- (ii) Explain why she would need this amount of calcium.

7dii

1 mark

maximum 7 marks

8. The diagram shows a plant cell.

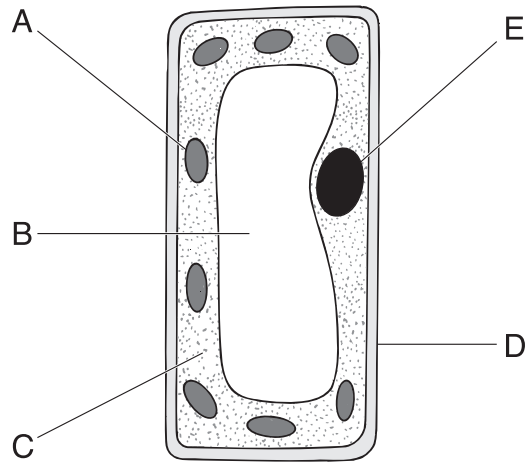

(a) Give the name of part A.

Give the function of part A.

(b) Give the name of part E.

Give the function of part E.

8a
1 mark

8a
1 mark

8b
1 mark

8b
1 mark

-
- (c) Give the letters of **two** parts that are present in plant cells but **not** in animal cells.

_____ and _____

8c
1 mark

- (d) How can you tell that the cell on the opposite page is from a leaf and **not** from a root?

8d
1 mark

maximum 6 marks

9. (a) Peter had two different coloured tennis balls as shown below.



He shone white light through a red filter onto each ball.

(i) **experiment 1**

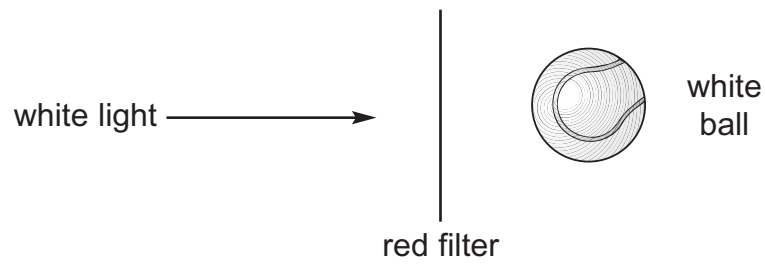

The white ball appeared red.
Explain why this ball appeared red.

(ii) **experiment 2**

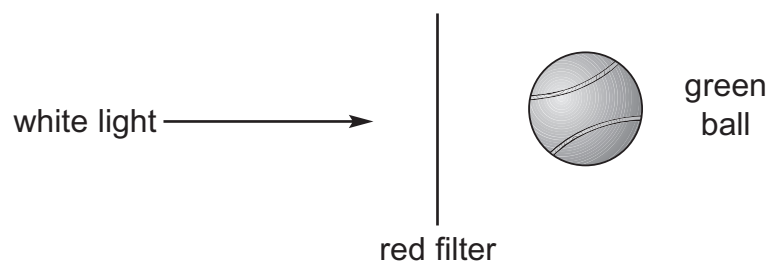

What colour did this ball appear?

Explain your answer.

9ai
1 mark

9ai
1 mark

9aii
1 mark

9aii
1 mark

- (b) Peter set up a different experiment.
He cut three holes in a piece of card.
Two of the holes were covered by coloured filters as shown below.

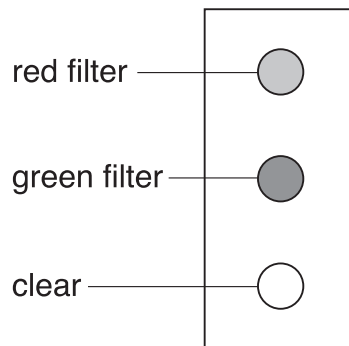

Peter placed a red filter between the piece of card and a white screen.
He shone white light at the piece of card with three holes in it.

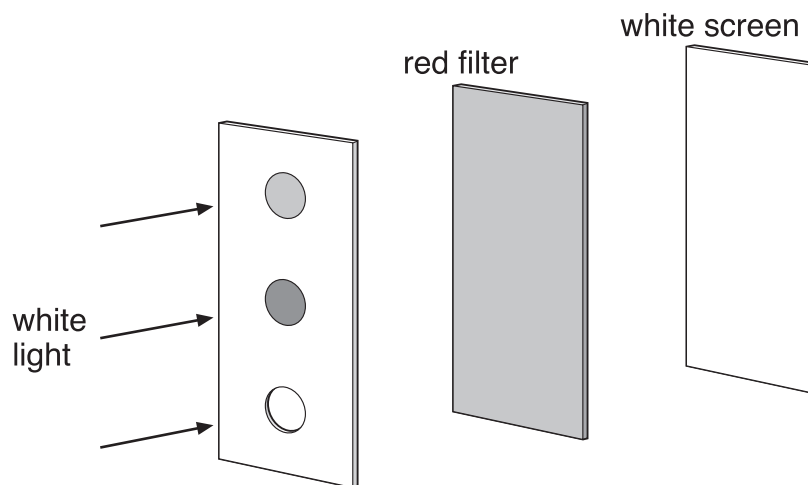

What would Peter see on the screen?

9b
1 mark

maximum 5 marks

10. Zena has a model plane attached to a rod as shown below. The plane is balanced by a sliding counterweight.

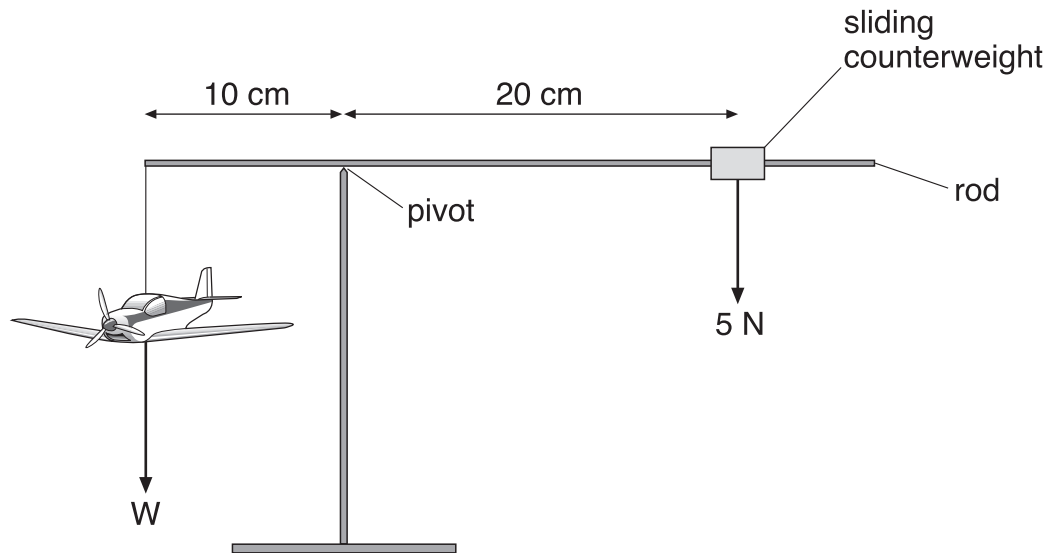

not to scale

- (a) The rod is balanced horizontally.

- (i) Calculate the turning moment produced by the counterweight about the pivot.
Give the unit.

10ai
1 mark

- (ii) What is the turning moment produced by the plane about the pivot?

10aii
1 mark

- (iii) Calculate the weight, W , of the plane.

10aiii
1 mark

_____ N

-
- (b) There is a solar cell on the surface of the model plane.
Zena connected the solar cell to the motor of the plane.
The plane moved in a circle around the pivot.

Part of the path of the plane was in a shadow.
What happened to the speed of the plane as it moved from bright light
into low light in the shadow?

Explain your answer.



10b

1 mark

maximum 5 marks

11. A company that sells bottled water claims in its advertisement:

Tap water contains large clusters of molecules. These are too large to pass through the tiny channels in the cell membranes that allow water into the cells of our bodies. Our special process makes the clusters of water molecules small enough to pass through the tiny channels.

A scientist says:

Water is absorbed by cells one molecule at a time so the size of the clusters of molecules does not matter.

(a) What claim made by the company is the scientist challenging?



11a

1 mark

(b)



Another company that sells bottled water makes these claims on its label:

This water makes you feel more beautiful.

This water reduces your blood pressure.

Explain why it is more difficult to compare any effects of drinking water on feeling more beautiful than on blood pressure.



11b

1 mark

(c) Consumers called for an 'independent study' of the company's claims.

Why is it important that any future study is 'independent' of the company?

11c
1 mark

(d) Any study of the effects of different types of water should be done with people who do **not** know which type of water they are drinking.

Give a reason for this.

11d
1 mark

maximum 4 marks

12. Harry mixed zinc with copper sulphate solution in a test-tube.
A displacement reaction took place and the temperature increased.

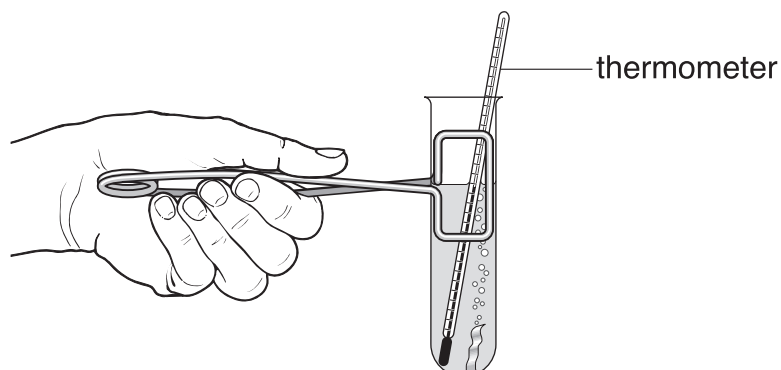

- (a) The word equation for the reaction is shown below.

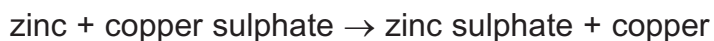

Why is this reaction called a displacement reaction?

12a
1 mark

- (b) Harry repeated the experiment with two other metals.
He wanted to calculate the temperature rise each time.
His results are shown below.

metal added to copper sulphate	temperature at the start (°C)	highest temperature reached (°C)	rise in temperature (°C)
zinc	20.0	36.5	16.5
iron	25.5	38.5	13.0
magnesium	19.5	87.5	68.0

Harry used different starting temperatures.
Explain why this did **not** affect his results.

12b
1 mark

(c) Part of the reactivity series of metals is shown below.

most reactive sodium
 calcium
 magnesium
 aluminium
 zinc
 iron
 lead
least reactive copper

Use the reactivity series above to answer all the questions below.

(i) Why was the highest rise in temperature obtained with magnesium and copper sulphate?

12ci
1 mark

(ii) Why was the rise in temperature obtained with zinc and copper sulphate **not** much higher than the rise in temperature obtained with iron and copper sulphate?

12cii
1 mark

(iii) In which of the following mixtures would there be a rise in temperature? Write **yes** or **no** in each blank box.

mixture	Would there be a rise in temperature?
aluminium + sodium chloride	
calcium + zinc sulphate	
lead + zinc chloride	
magnesium + iron chloride	

12ciii
1 mark

12ciii
1 mark

maximum 6 marks

13. **Diagram 1** shows the female reproductive system.

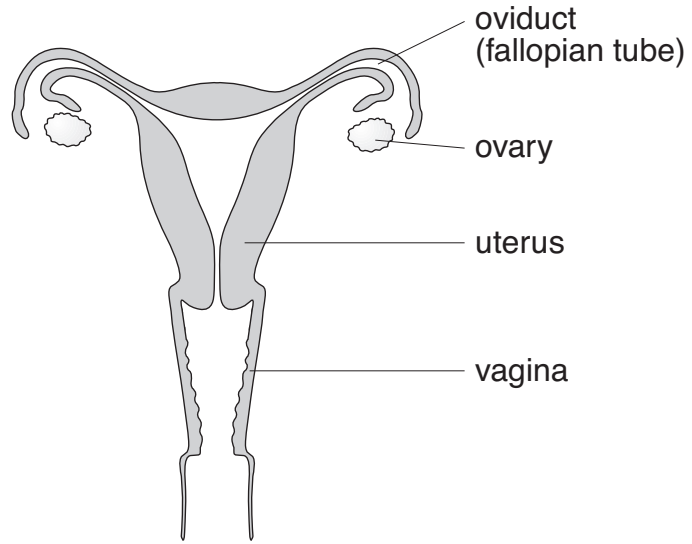

diagram 1

(a) **Diagram 2** is a graph showing how the thickness of the uterus changed over a 28-day cycle.

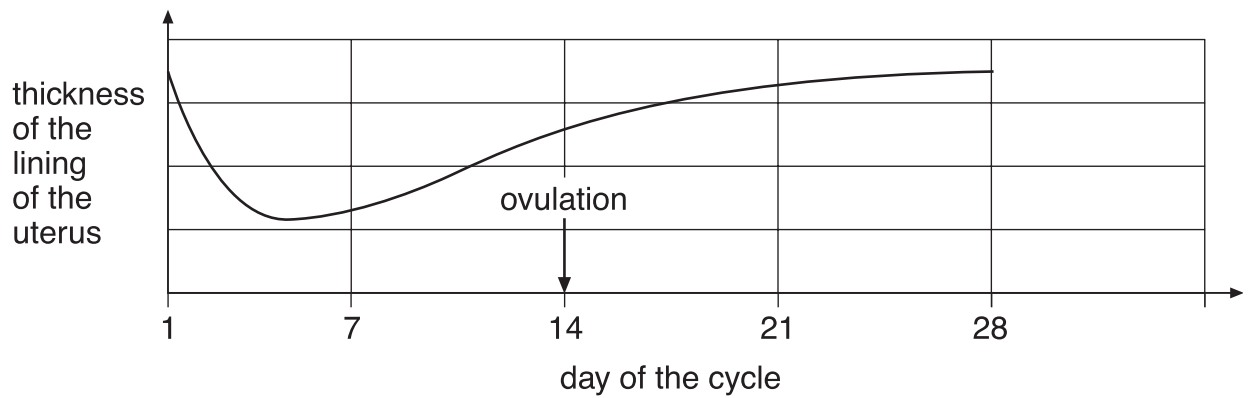

diagram 2

(i) Why did the thickness of the lining of the uterus decrease between day 1 and day 5 of this cycle?



13ai

1 mark

(ii) Suggest which day in this cycle an ovum (egg) is most likely to be fertilised.

day _____

What evidence is there for this in the graph?

13aii
1 mark

(iii) The graph shows that the lining of the uterus builds up again between day 5 and day 14.

Why is this necessary?

13aiii
1 mark

(b) (i) Continue the line on the graph to show what would happen to the thickness of the lining of the uterus after 28 days if an ovum was fertilised.

13bi
1 mark

(ii) Explain your answer.

13bii
1 mark

maximum 5 marks

14. The life cycle of the housefly is shown below.

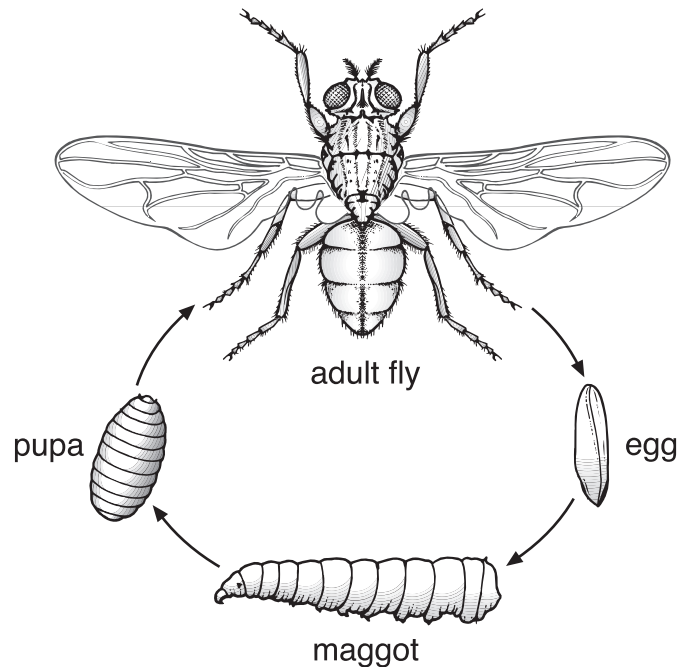

not to scale

Before the seventeenth century, people believed that maggots found on rotting meat came either from the meat **or** from the air and **not** from eggs of the housefly.

In 1668, a doctor named Francesco Redi placed some meat into three separate containers:

- container 1, left open to the air
- container 2, sealed with a lid
- container 3, covered with a fine mesh.

He left the containers for several days in a room containing adult houseflies. His results are shown below.

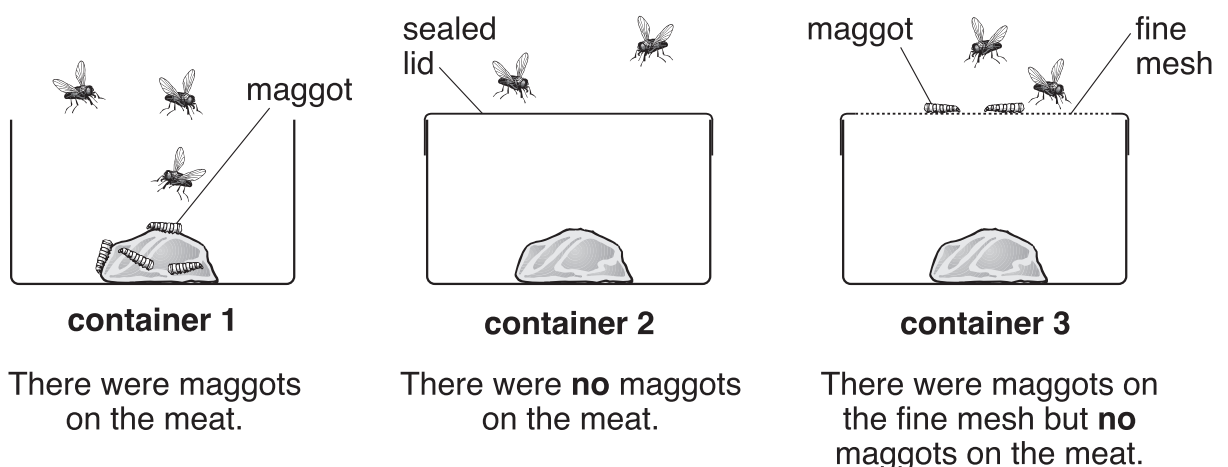

(a) Look at the drawings opposite and read the sentences beneath them.

(i) How do Redi's results show that maggots do **not** come from rotting meat?

14ai
1 mark

(ii) How do Redi's results show that maggots do **not** come from the air?

14aii
1 mark

(b) The maggots that hatched on the meat in container 1 could complete their life cycle.

Explain why the maggots that hatched on the mesh on container 3 could **not** complete their life cycle.

14b
1 mark

(c) Give **two** reasons why meat should be kept in a refrigerator.

1. _____
2. _____

14c
1 mark

14c
1 mark

END OF TEST

maximum 5 marks

